

Norcar 765



For heavy tasks

The largest loader in the 700- series offers great accessibility and a robust construction. The four-cylinder engine has plenty of power and gives a smooth ride. Extension boom, traction control, and efficient hydraulics contribute to making the 765 a powerful work machine for the toughest jobs.

The drivetrain is hydrostatic and differs from other Norcar models. Travel direction is chosen using a forward/reverse switch on the joystick. The drive speed is controlled using a gas pedal and the drive disengages when idling. The machine has a brake pedal that can be used to decrease the travel speed during high engine speed.



On the Norcar 765, travel direction is chosen using a switch on top of the joystick.



Engine

Make	Kubota
Model	1505
Cylinders	4
Fuel type	Diesel
Cylinder volume cm ³	1498
Cooling system	Fluid

Power

SAE, gross power kW/hp	27/37
Max gross torque Nm	98
At engine speed r/min	2200
Max engine speed without load r/min	3000

Electrical systems

Battery V-Ah	12- 62
Generator A	40

Service volumes

Cooling system l	6
Engine oil l	5
Fuel tank l	20
Hydraulic tank l	45
Hydraulic system total volume l	50

Performance

Lifting power hydraulic kg	1500
Breakout force 50cm kg	1600
Tipping load, straight kg	1200
Tipping load, articulated kg	750
Operating weight kg	1630
Drive speed km/h	0-15
Pulling force kg	1200

Hydraulic system

Working hydraulics l/min	50
System pressure bar	200
Drivetrain hydraulics l/min	84
Drivetrain max system pressure bar	350

Cycle times

Raising boom s	2,5
Lowering boom s	1,7
Folding in bucket s	1,8
Tipping bucket s	2,3
Steering wheel rotations L/R rev	3/4

Tires

Dimension	27x10,5-15 IN
-----------------	---------------

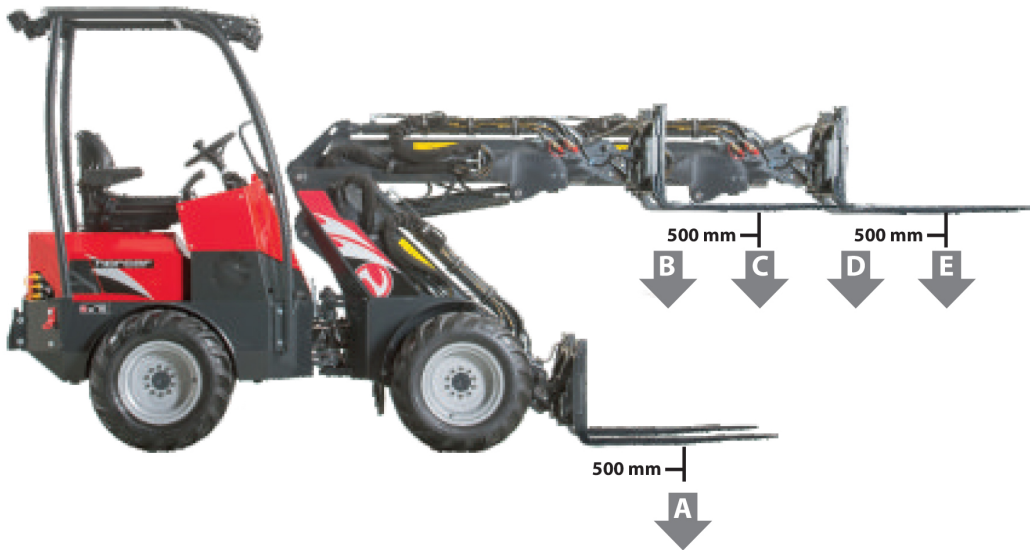

Standard machine

+extra counter weights 180 kg

Tipping load with pallet forks	Straight	Articulated	Straight	Articulated
A. Transport position kg	1070	780	1280	940
B. Boom horizontal kg	1350	980	1440	950
C. Boom horizontal kg	980	625	1250	740
D. Boom horizontal + extension kg	975	650	1100	800
E. Boom horizontal + extension kg	735	485	980	550

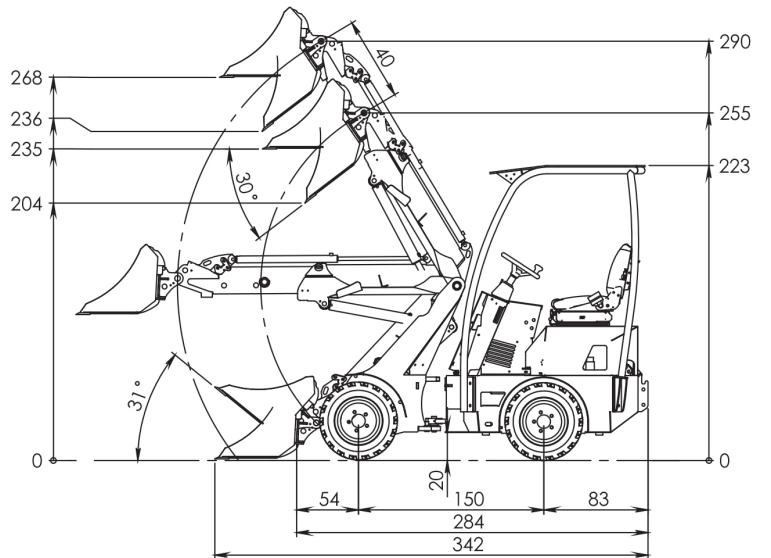
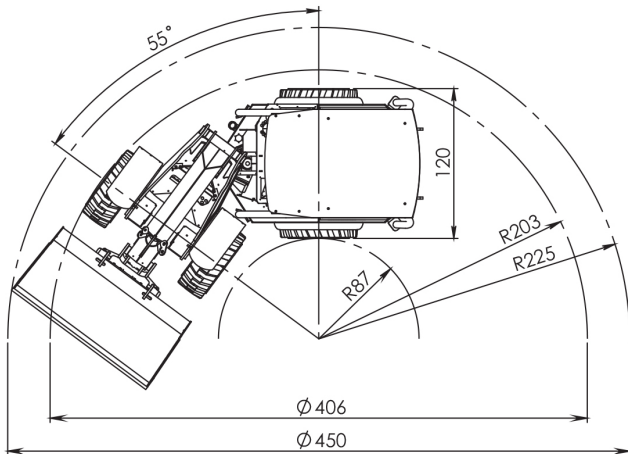

Standard Equipment

- Roll bar ROPS, seatbelt
- Working lights, front
- Electrically maneuvered parking brake/safety system
- Float on the lifting boom
- Hand throttle/Foot throttle
- Hour counter, engine heat indicator, fuel light
- Suspension seat with armrests

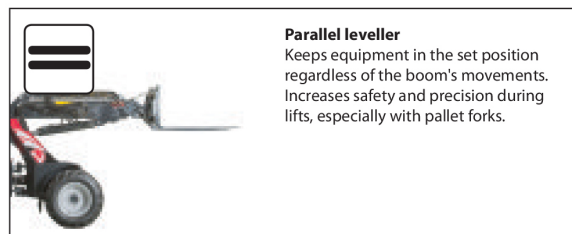

Parallel leveller

Keeps equipment in the set position regardless of the boom's movements. Increases safety and precision during lifts, especially with pallet forks.

Standard Equipment 765



Telescope Extension Boom
400mm telescope boom gives good lifting height and reach. Electronically controlled using lifting boom's joystick.



Hydraulic Outlet, front
Double acting hydraulic outlets, front (1 and 2) and free return (3). Controls hydraulic tools using a manual lever. Mode for continuous operation and free return useful for eg. lawn mowers. Hydraulic oil flow max 50l/min.



Tire 27 x 10,5 -15 IN
Durable multi-purpose tire that can withstand heavy loads. Suitable for work on harder surfaces such as asphalt, concrete, and hard packed gravel. Machine width 120 cm.

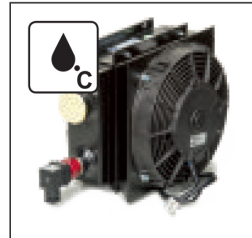

Hydraulic Oil Cooler
Maintains hydraulic oil's temperature at correct level while operating tools that require high oil flow during long driving periods.

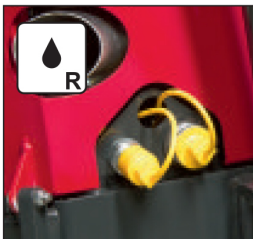

Hydraulic Outlet, rear
Single acting hydraulic outlet (R1) and free return (R3). A push button selects whether front or rear outlet is used. Hydraulic oil flow max 50l/min.



Full traction control
Provides continuous traction on all wheels, regardless of terrain.

Additional Equipment 765

Driving Options



Oscillation lock
Locks the loader's pendular movement in the joint. Can be used during eg. leveling tasks when the tool needs to be parallel to the rear wheels.

7003360

Tires



Tire 26,5 x 14-12 GR
Densely patterned tire. Soft tire that is gentle to surfaces and grips well. Suitable for work on grass, gravel paths and roads. The tire is also good on snow and ice. Tire width gives low ground pressure. Machine width 133cm.

7003368



Tire 27 x 10-12 IN
Compact puncture proof tire without air. Durable and can withstand heavy loads. Increases machine weight. Machine width 115 cm.

7003369



Tire 26 x 12-12 IN
Durable multi-purpose tire that can withstand heavy loads. Suitable for work on harder surfaces such as asphalt, concrete, and hard packed gravel. Machine width 126cm.

7003370



Tire 320 /60-12 TR
Durable, tractor patterned tire that can withstand heavy loads. Suitable for work on hard surfaces but also gives good traction on soft ground. Machine width 129 cm.

7003371

Hydraulics



Electrically Operated Hydraulic Outlet
Controls front hydraulic outlet directly from joystick. Outlet's mechanical lever can still be used.

7003378



Lifting Boom multi-function socket
Joystick equipped with control buttons for power outlets on the lifting boom. Gives ability to electrically control four signals (2 double-acting movements on tools equipped with electrical valves).



Lifting Boom Socket
7-pin socket for connection of special attachments. Included in 7003377.

Traffic



Traffic Equipment

Lights and equipment necessary for driving on public roads. Inspection and registration is required for driving on public roads and can vary between countries. Consult your dealer for advice regarding inspection in your region.

7003363



Rear View Mirrors

Rear view mirrors mounted on each side of the loader. The mirrors provide a comfortable and secure drive.

7003413

Additional Accessories



Beacon Light

Warns surroundings of working vehicle.

7003361



Seat Heater

Heat in the seat's sitting part increases comfort when driving in cold weather.

7003366



Seat Rotation

The seat can easily be rotated when working with equipment mounted at the back of the machine, eg. backhoe.

7003367



Counter Weight 45 kg

Increases the machine's stability during handling of heavy loads. Easily installed without tools on Mounting Plate 7003375. Max 4x (180kg).

7003374

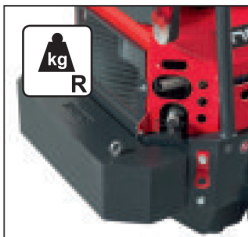

Counter Weight 205 kg

Compact counter weight, attached and secured with bolts. Lifting lugs for easy mounting. The weights cannot be used together with other rear mounted equipment.

7003386



Mounting Plate for Counter Weight and Hitch Bracket

Mounting plate for attaching hitch, along with space for 4 x 45 kg extra weights.

7003375



Reversing Beep

Warns surroundings of reversing vehicle.

7003362



Engine Pre-heater

Improves starting ability and decreases wear during cold starts. Recommended plug-in time 30 min.

7003359



FOPS Protective Roof

Steel roof that protects the operator from falling objects. Recommended for rental machines and is often mandatory on construction sites.

7003278



Hitch

Hitch with standard 50 mm ball. Mounting Plate 7003375 needed for installation.

7003372



Hitch Combo

Hitch with standard 50 mm ball combined with pin for trailer towing eye. Mounting Plate 7003375 needed for installation.

7003373



Rear Working Lights

Effective lighting, mounted at the back of the protective cage.

7003413

